













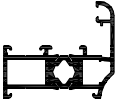
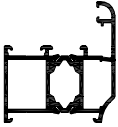

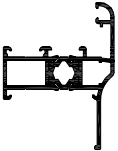
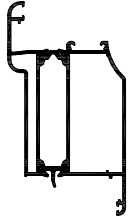
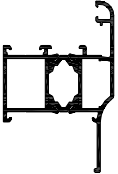
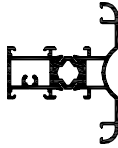
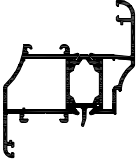
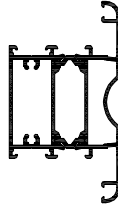
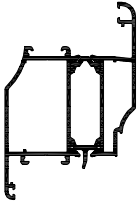

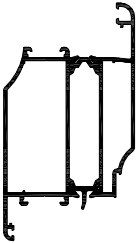
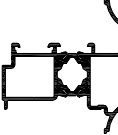



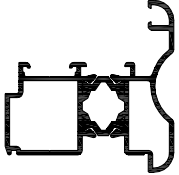
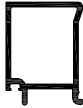









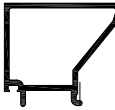

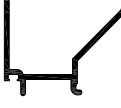
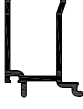
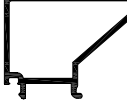

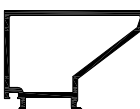
Red Line

					
	RL I AP F001	RL A 001			
	RL I AP F002	RL A 001		RL I AP V005	RL A 005
	RL I AP F005	RL A 002		RL I AP V006	RL A 006
	RL I AP F006	RL A 002		RL N AP M001	RL A 007
	RL I AP V001	RLA 003		RL N AP M002	RL A 007
	RL I AP V002	RL A 003		RL N AP M003	RL A 008
	RL I AP V003	RL A 004		RL I AP A001	RL A 009

Red Line

			
	RL I AP A002	RL A 009	
	X AC 0062	RL D 013	
	X AC 0068	RL D 007	
	X AP B007	RL X 001	
	X AP B009	RL X 001	
	X AP B011	RL X 001	
	X AP B013	RL X 001	
	X AP B015	RL X 001	
	X AP B017	RL X 001	

Red Line

	 A m ² /m	 P m ² /m	Jx	Jy					Kg / m
RL I AP F001	0,36	0,09	5	14	X AP C124/187	18,7 mm	X AP C124/81	8,1 mm	1,24
RL I AP F002	0,42	0,11	10	17	X AP C124/189	18,9 mm	X AP C124/81	8,1 mm	1,43

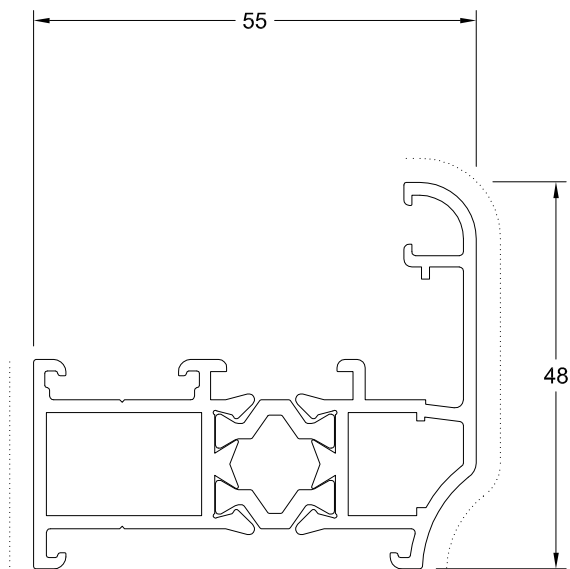



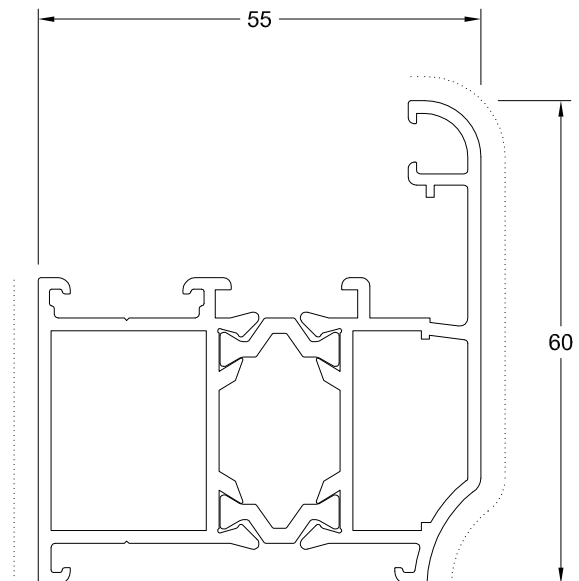



RL I AP F001



RL I AP F002

Red Line

	 A m ² /m	 P m ² /m	Jx	Jy					Kg / m
RL I AP F005	0,42	0,11	9	15	X AP C124/187	18,7 mm	X AP C124/81	8,1 mm	1,33
RL I AP F006	0,50	0,13	16	18	X AP C244/189	18,9 mm	X AP C244/81	8,1 mm	1,52

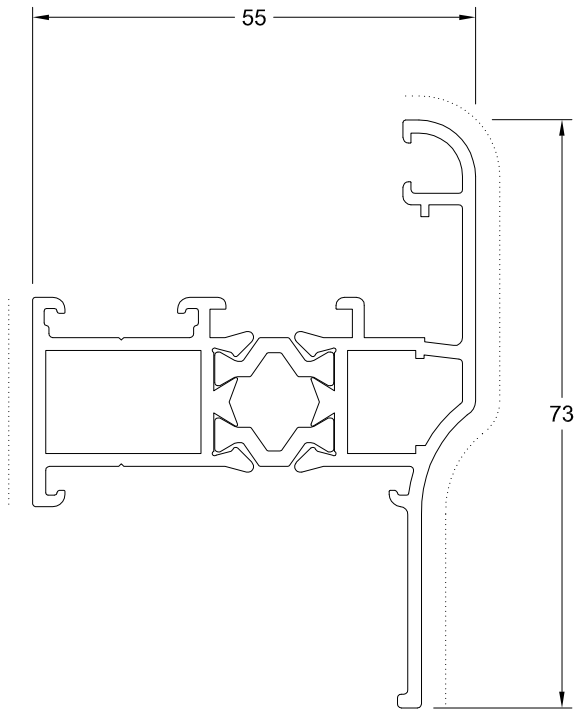



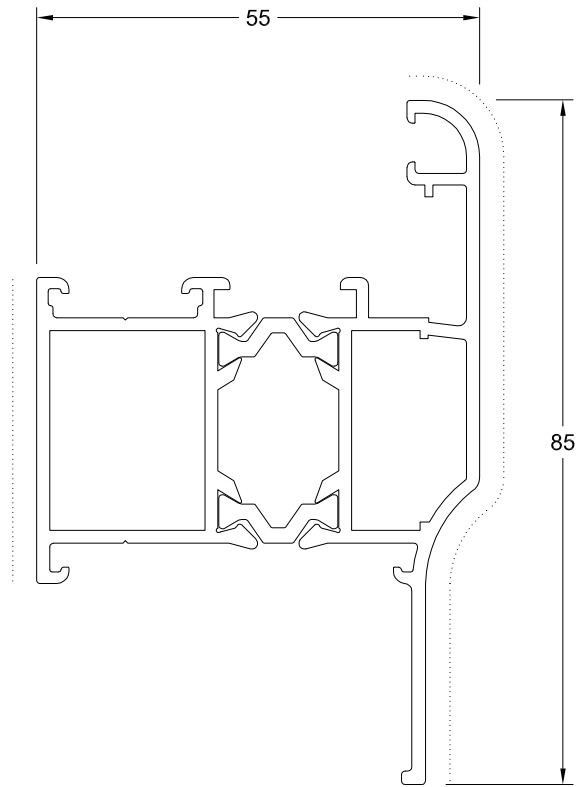

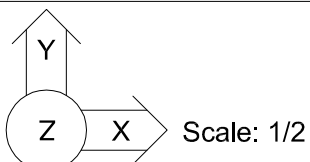

RL I AP F005



RL I AP F006



Red Line

	 A m ² /m	 P m ² /m	Jx	Jy					Kg / m
RL I AP V001	0,50	0,14	15	25	X AP C254/200	20,0 mm	X AP C254/47	4,7 mm	1,54
RL I AP V002	0,55	0,18	36	33	X AP C454/200	20,0 mm	X AP C454/47	4,7 mm	1,90

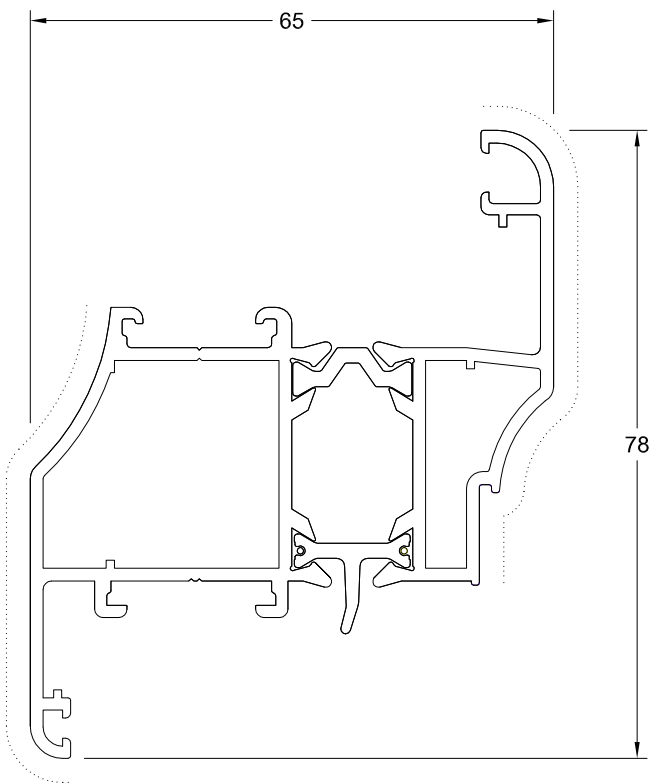



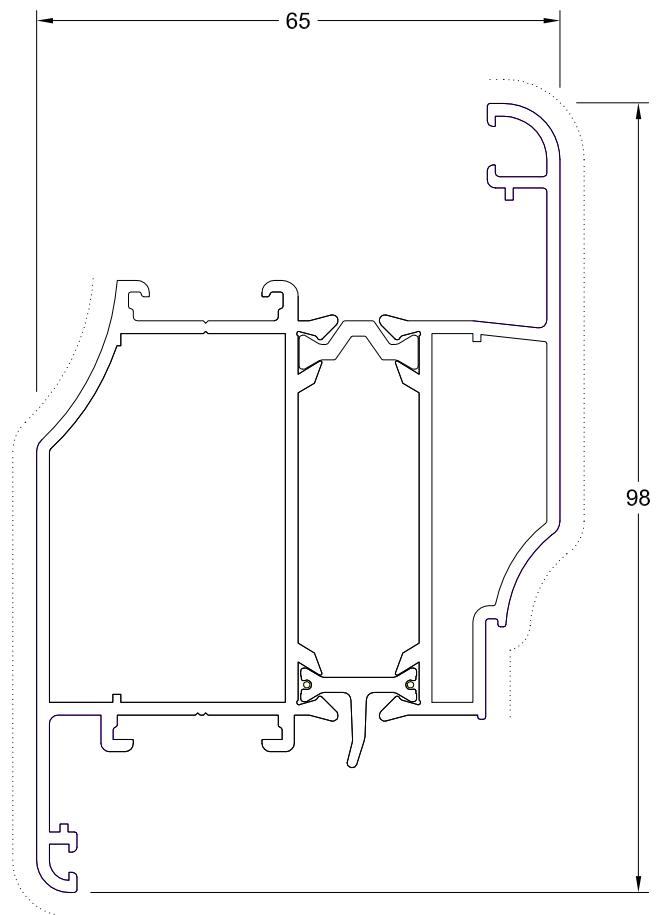



RL I AP V001



RL I AP V002





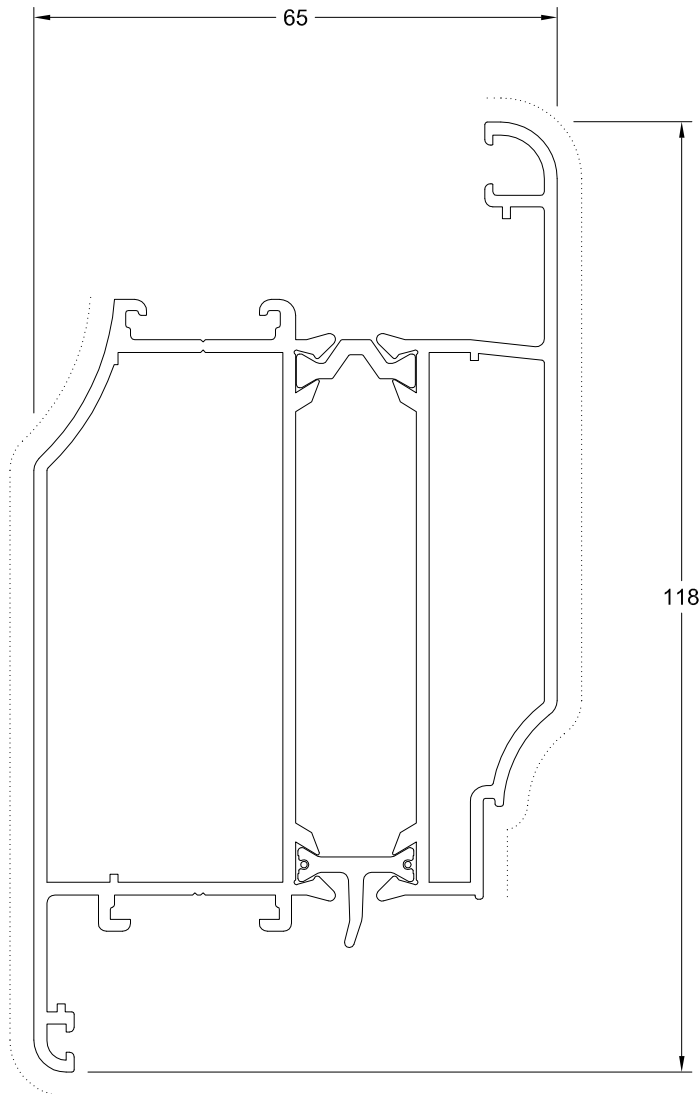

Red Line

			Jx	Jy					Kg / m
RL I AP V003	0,63	0,22	71	41	X AP C654/200	20,0 mm	X AP C654/47	4,7 mm	2,23







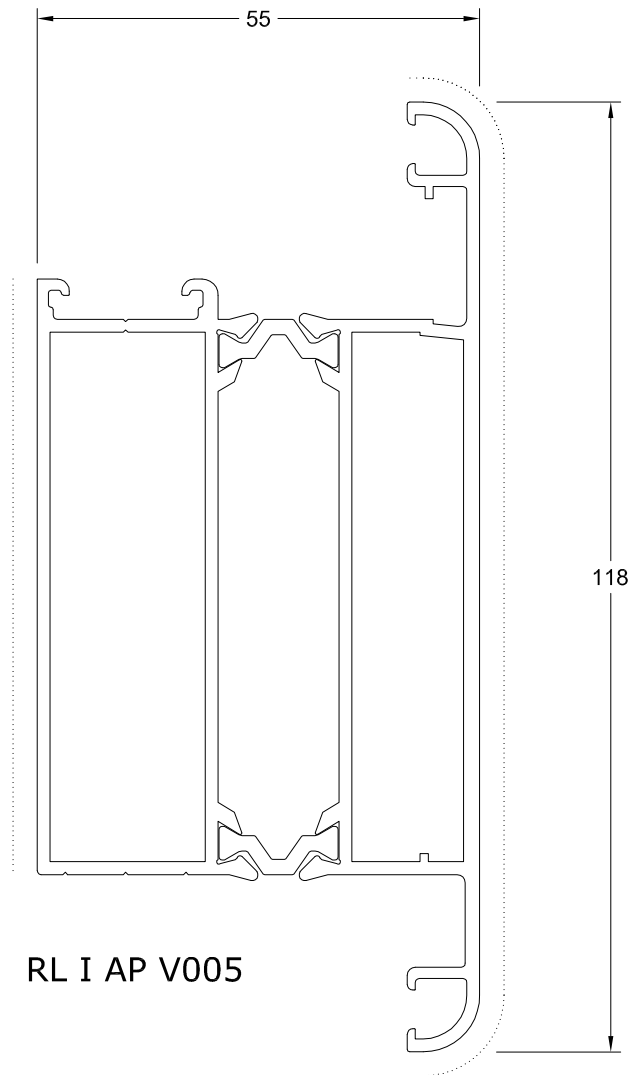

RL I AP V003

Red Line

	 A m ² /m	 P m ² /m	Jx	Jy					Kg / m
RL I AP V005	0,32	0,12	70	30	X AP C654/189	18,9 mm	X AP C654/81	8,1 mm	2,24







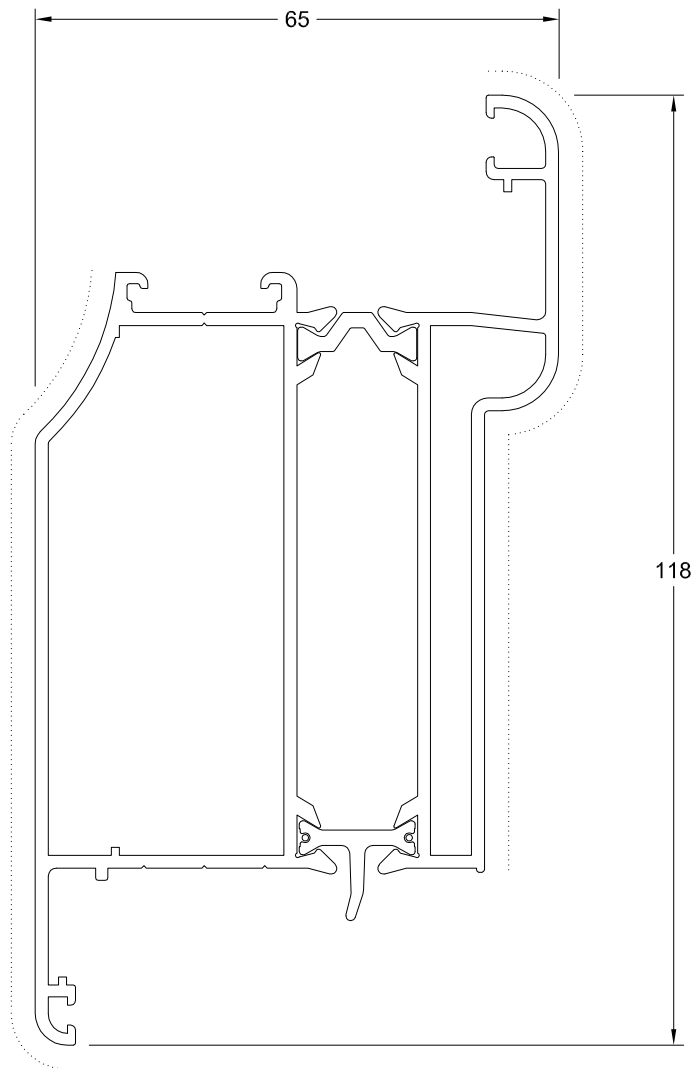

Red Line

	 A m ² /m	 P m ² /m	Jx	Jy					Kg / m
RL I AP V006	0,61	0,22	68	50	X AP C654/200	20,0 mm	X AP C654/47	4,7 mm	2,19



RL I AP V006

Red Line

	 A m ² /m	 P m ² /m	Jx	Jy					Kg / m
RL I AP M001	0,43	0,11	10	16	-	-	-	-	2,30
RL I AP M002	0,56	0,17	38	29	-	-	-	-	2,90

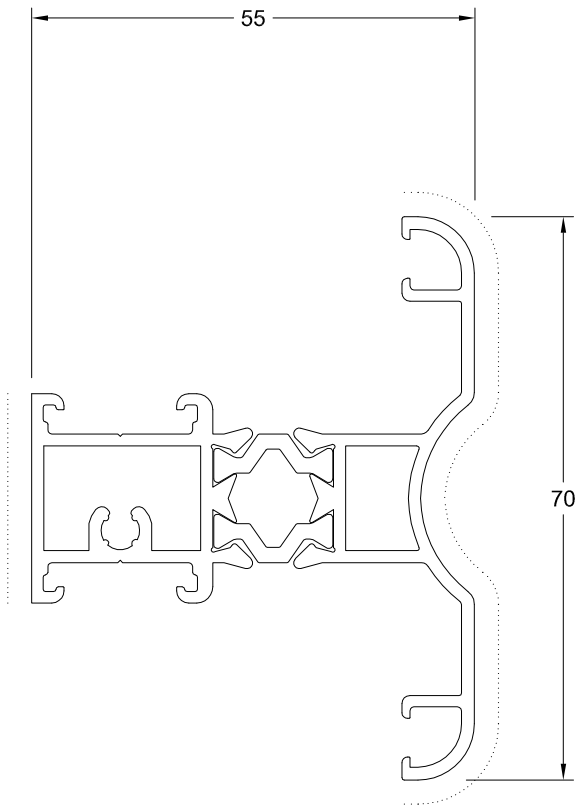



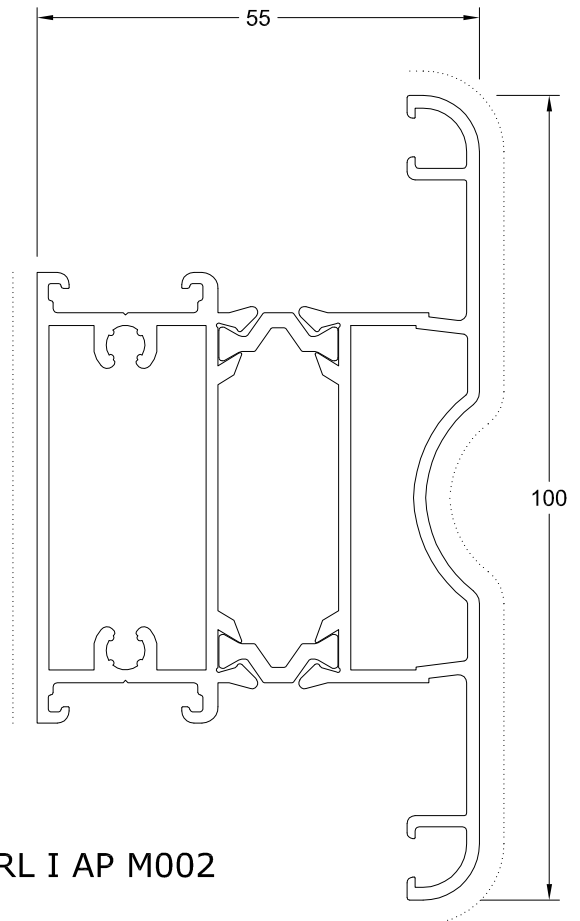



RL I AP M001



RL I AP M002





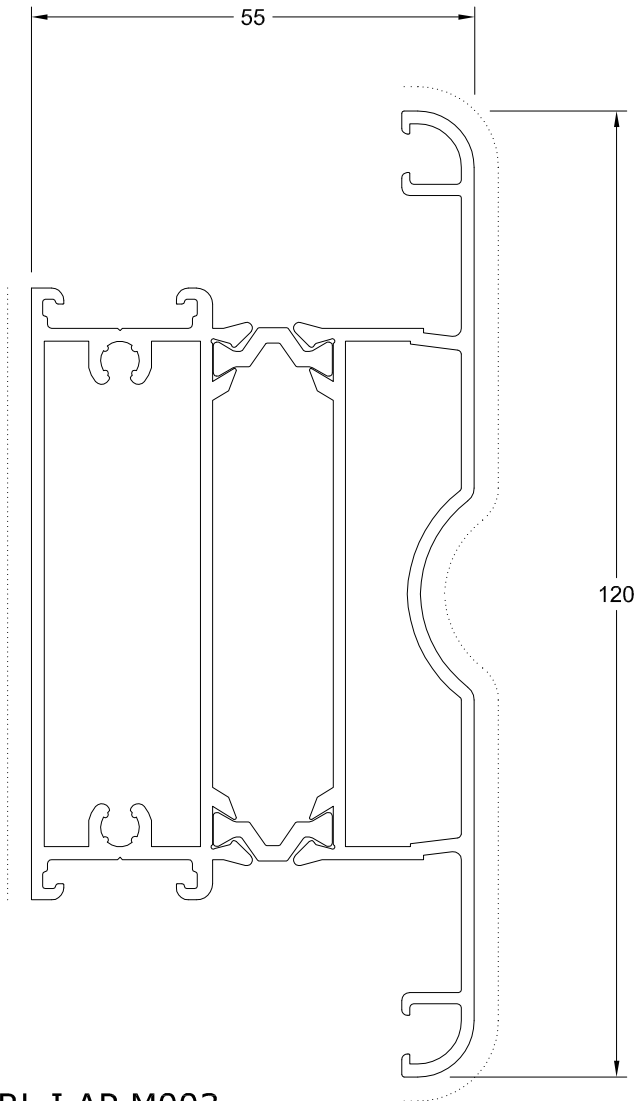

Red Line

	 A m ² /m	 P m ² /m	Jx	Jy					Kg / m
RL I AP M003	0,64	0,21	73	38	-	-	-	-	3,27



RL I AP M003

Red Line

	 A m ² /m	 P m ² /m	Jx	Jy					Kg / m
RL I AP A001	0,40	0,12	8	16	-	-	-	-	1,22
RL I AP A002	0,41	0,13	9	16	-	-	-	-	1,25

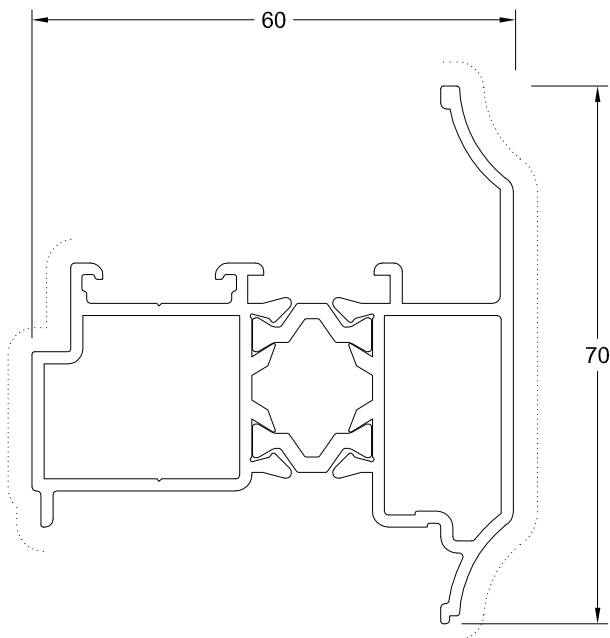

RL I AP A001

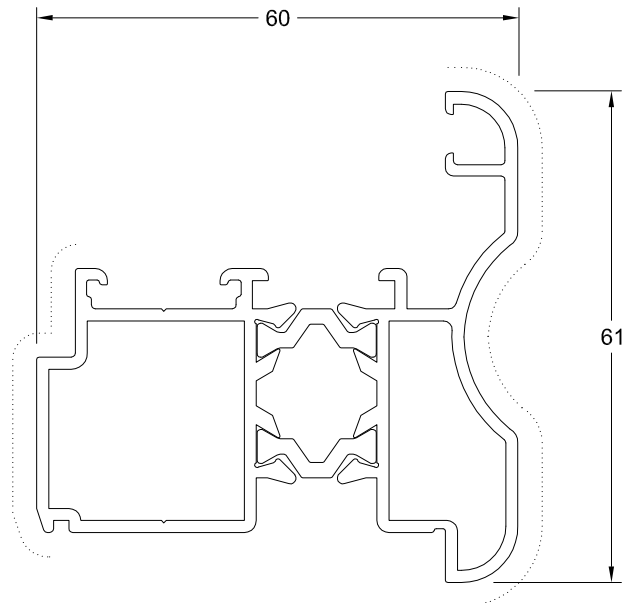

RL I AP A 002

Red Line

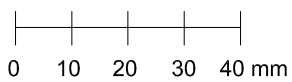
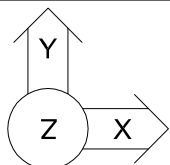
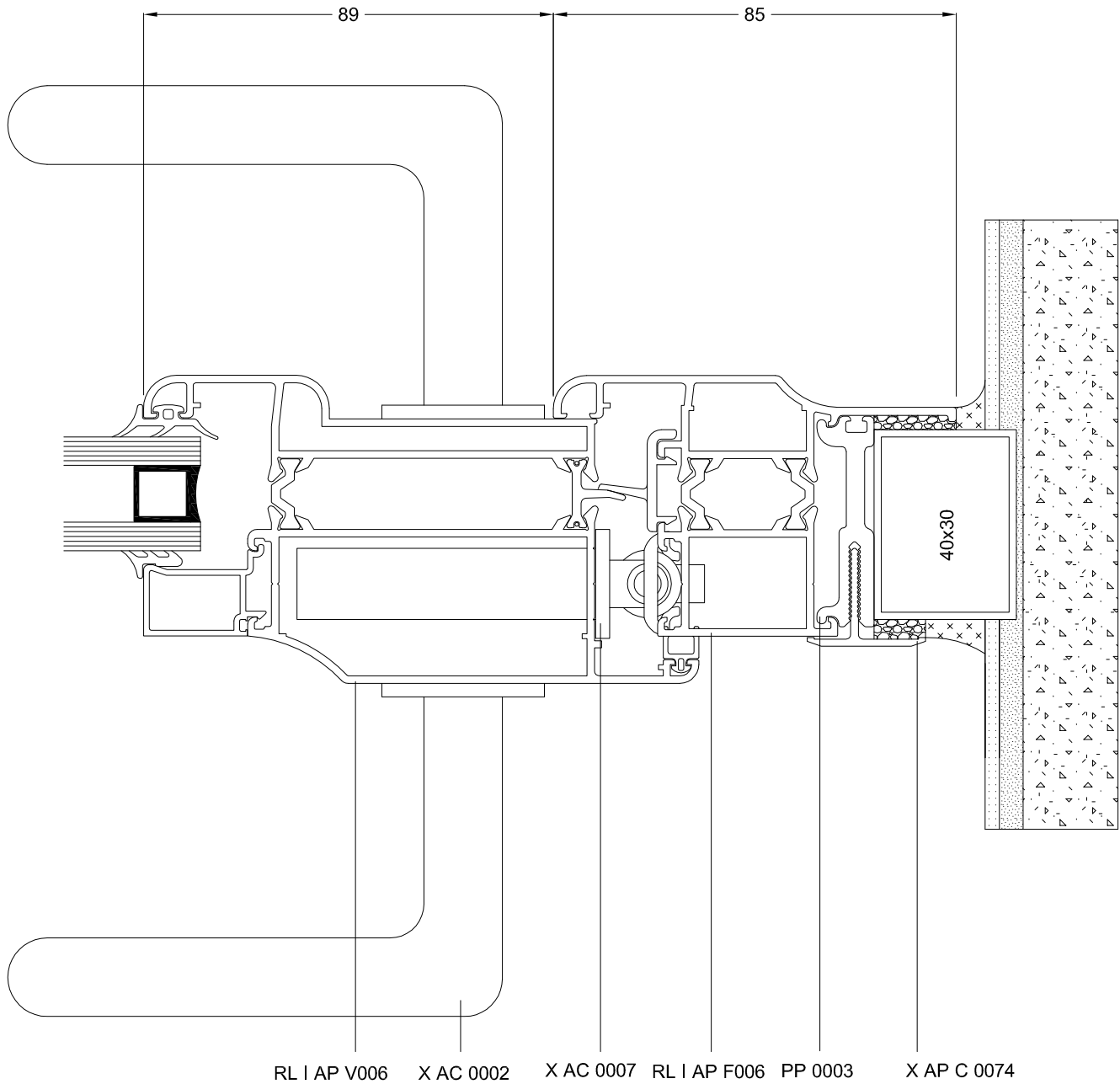

Red Line

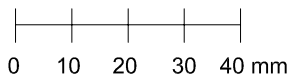
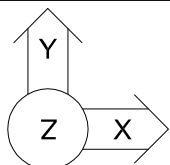
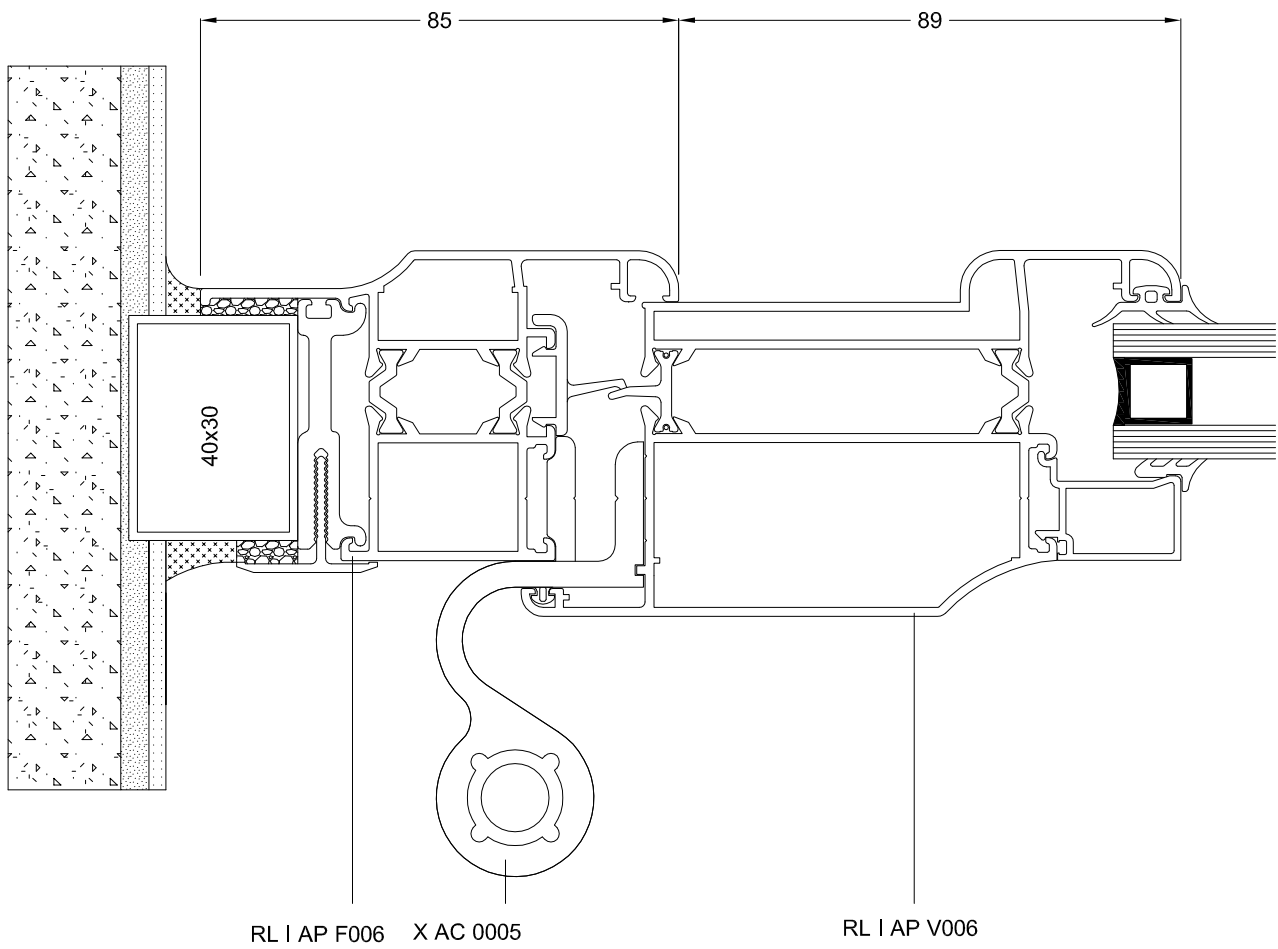

Red Line

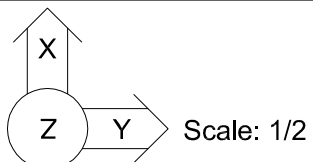
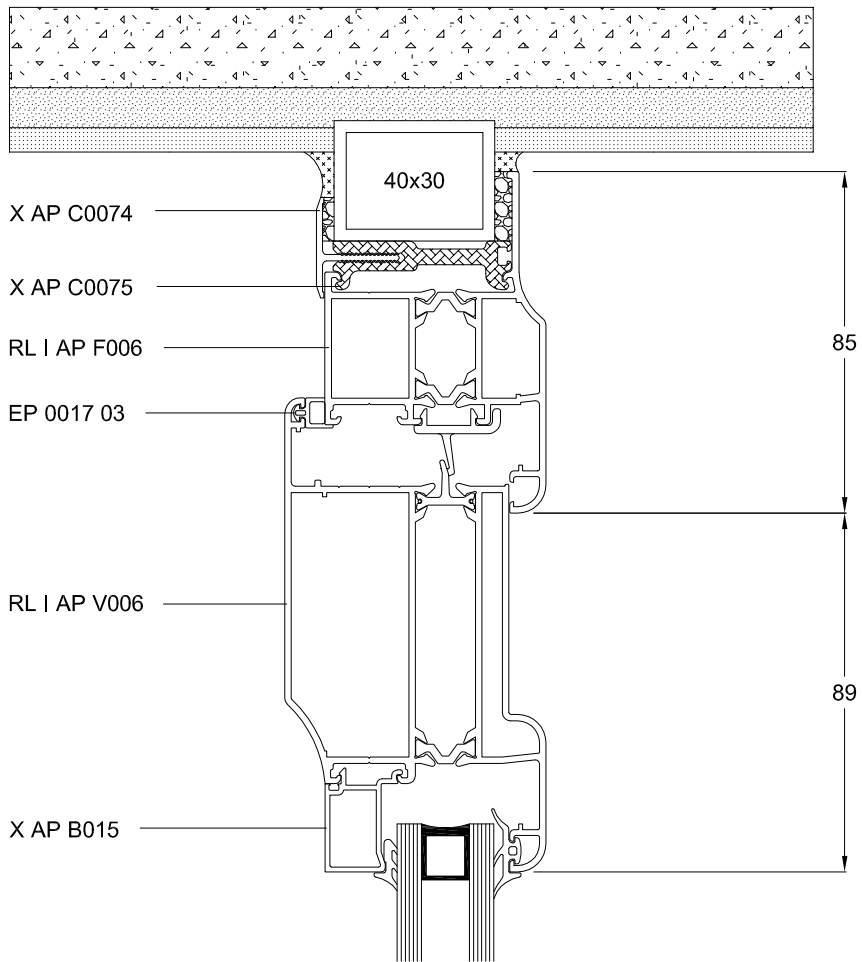

Red Line

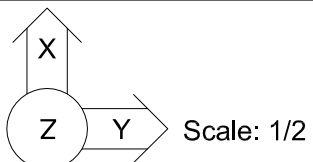
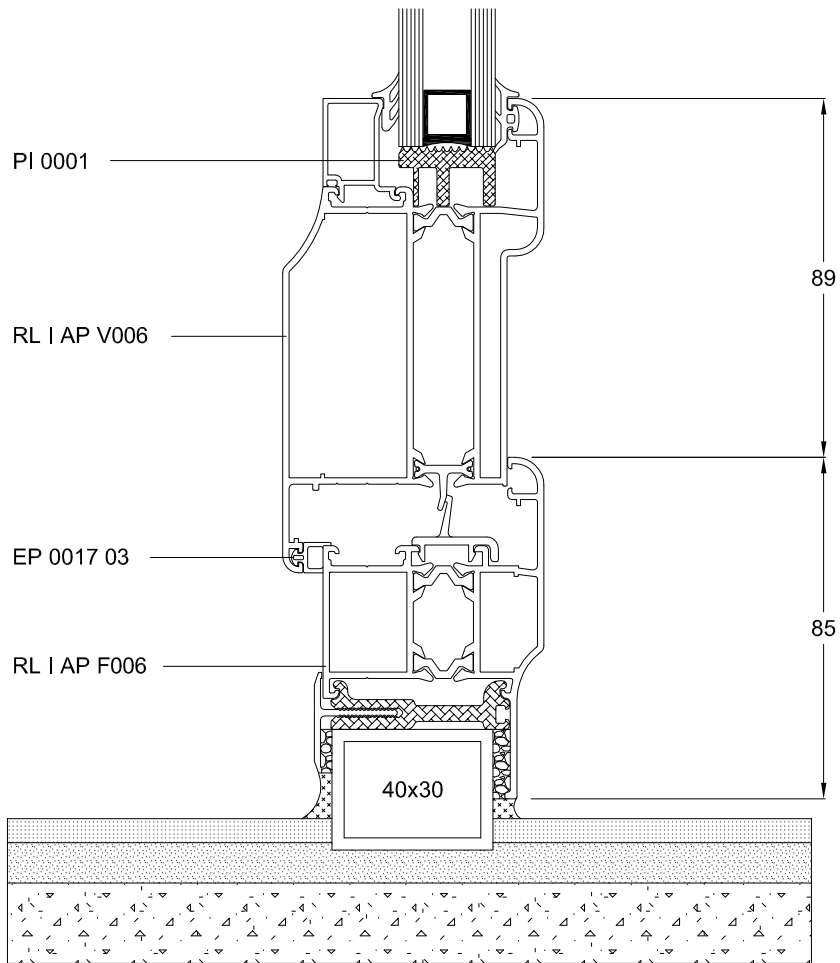

Red Line

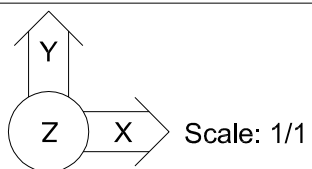
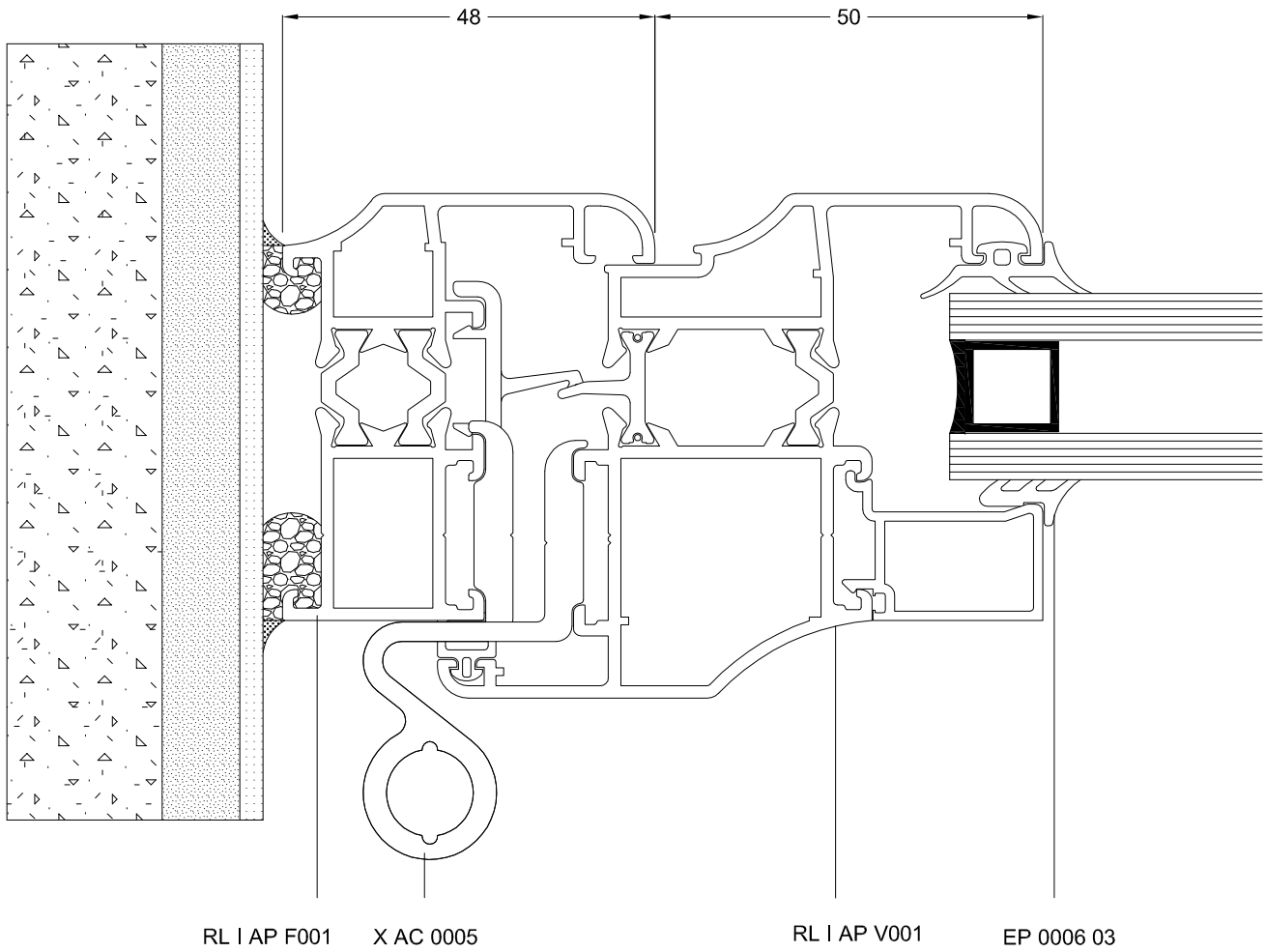

Red Line

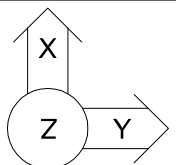
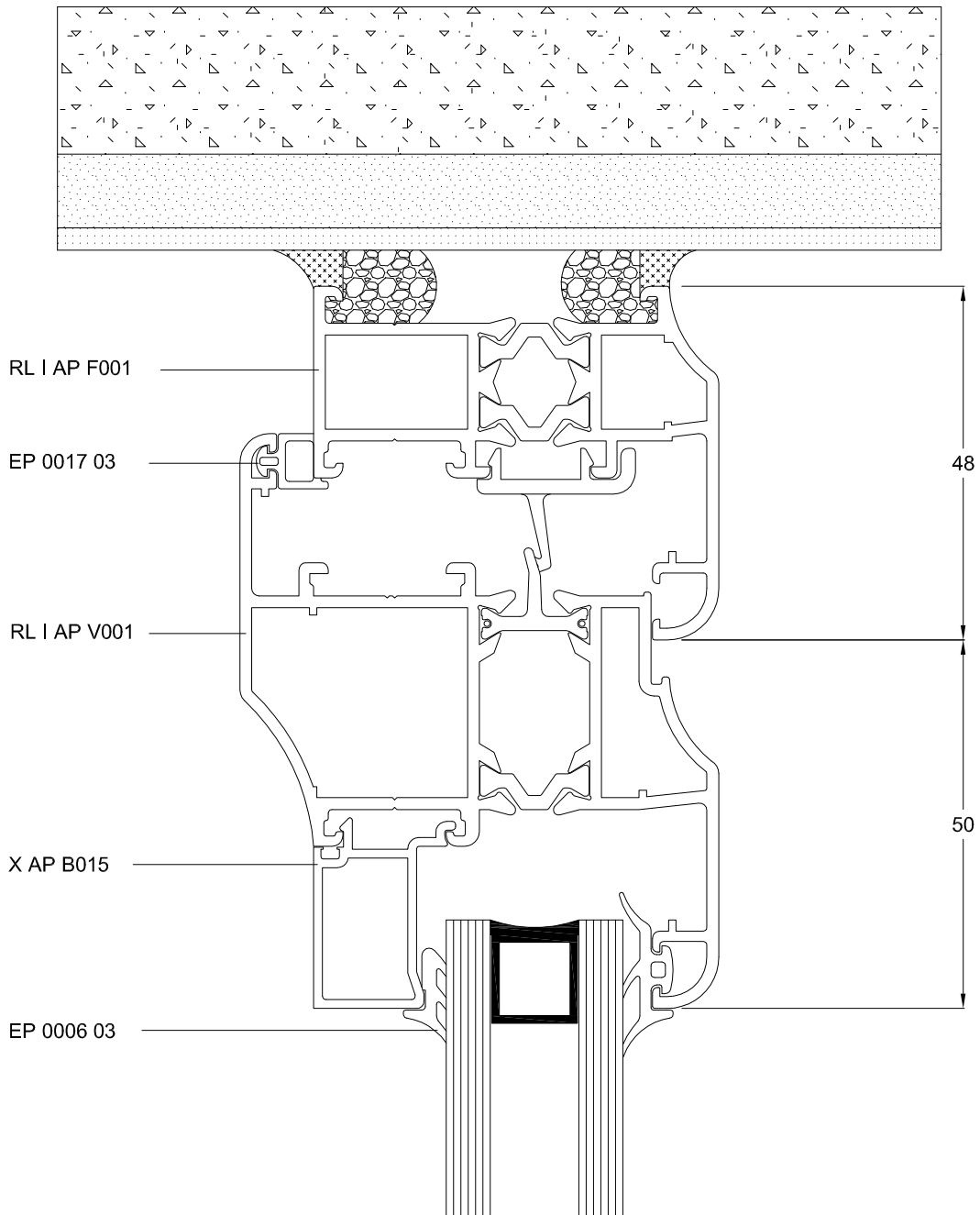

Scale: 1/1

Red Line

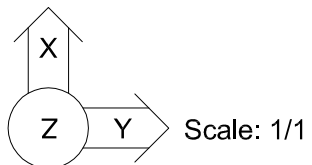
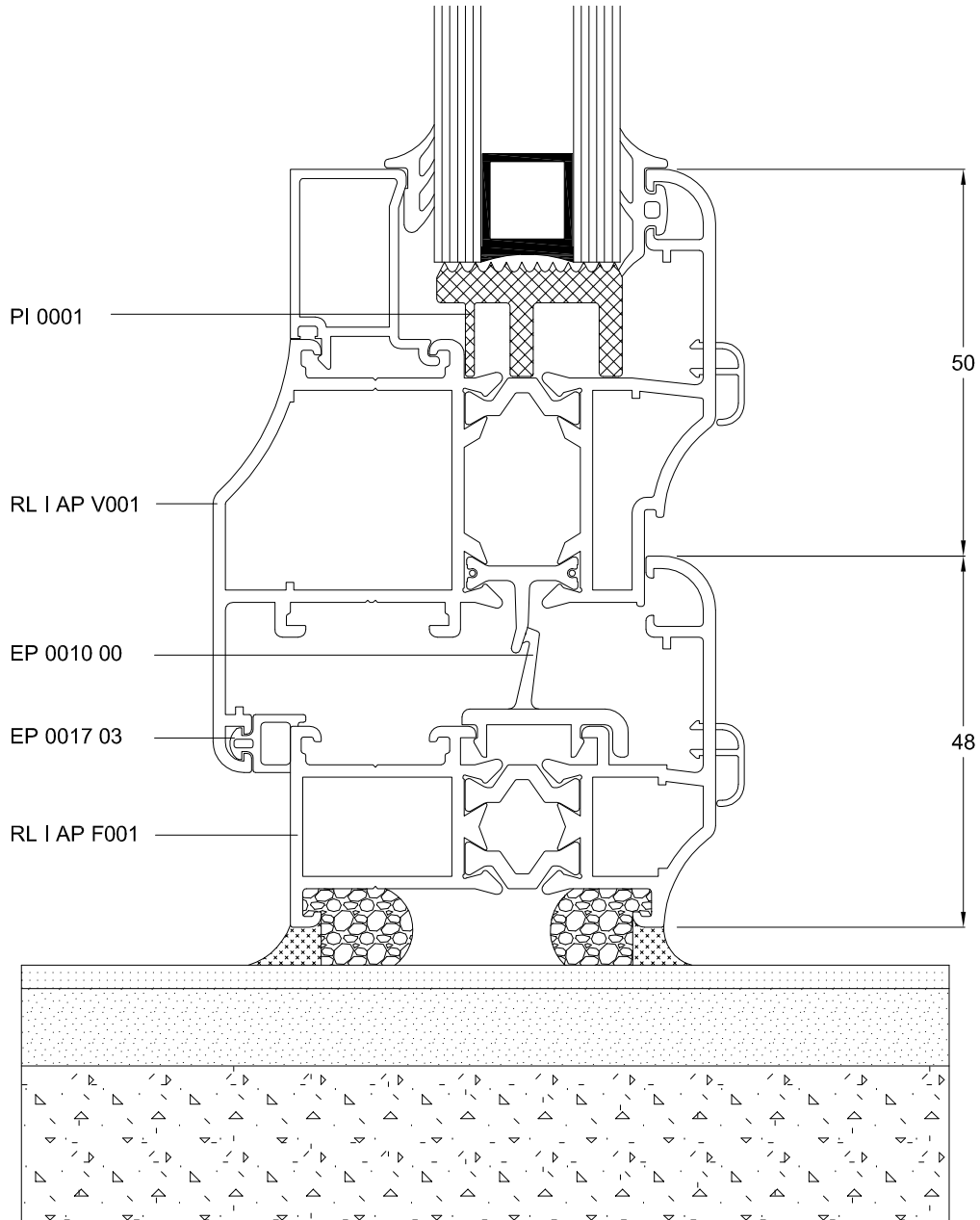

Red Line

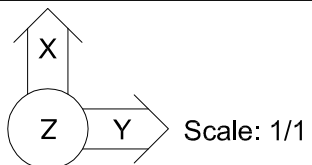
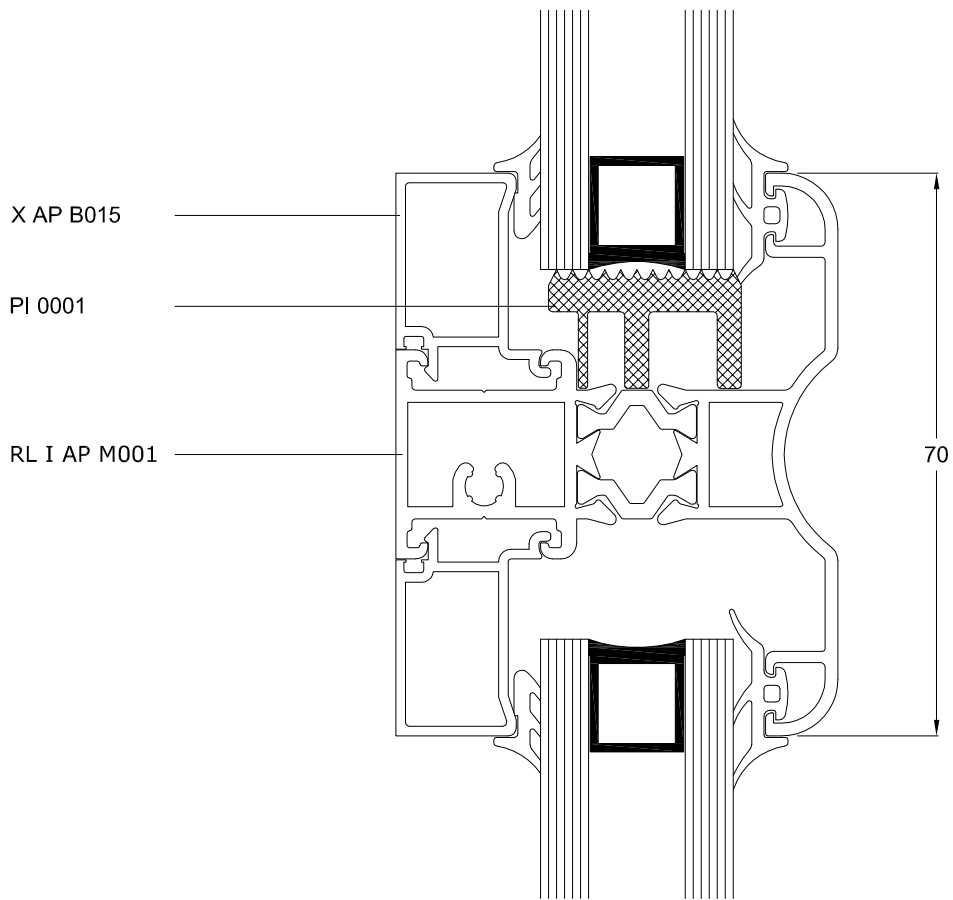

Red Line

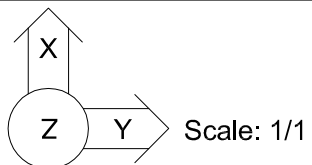
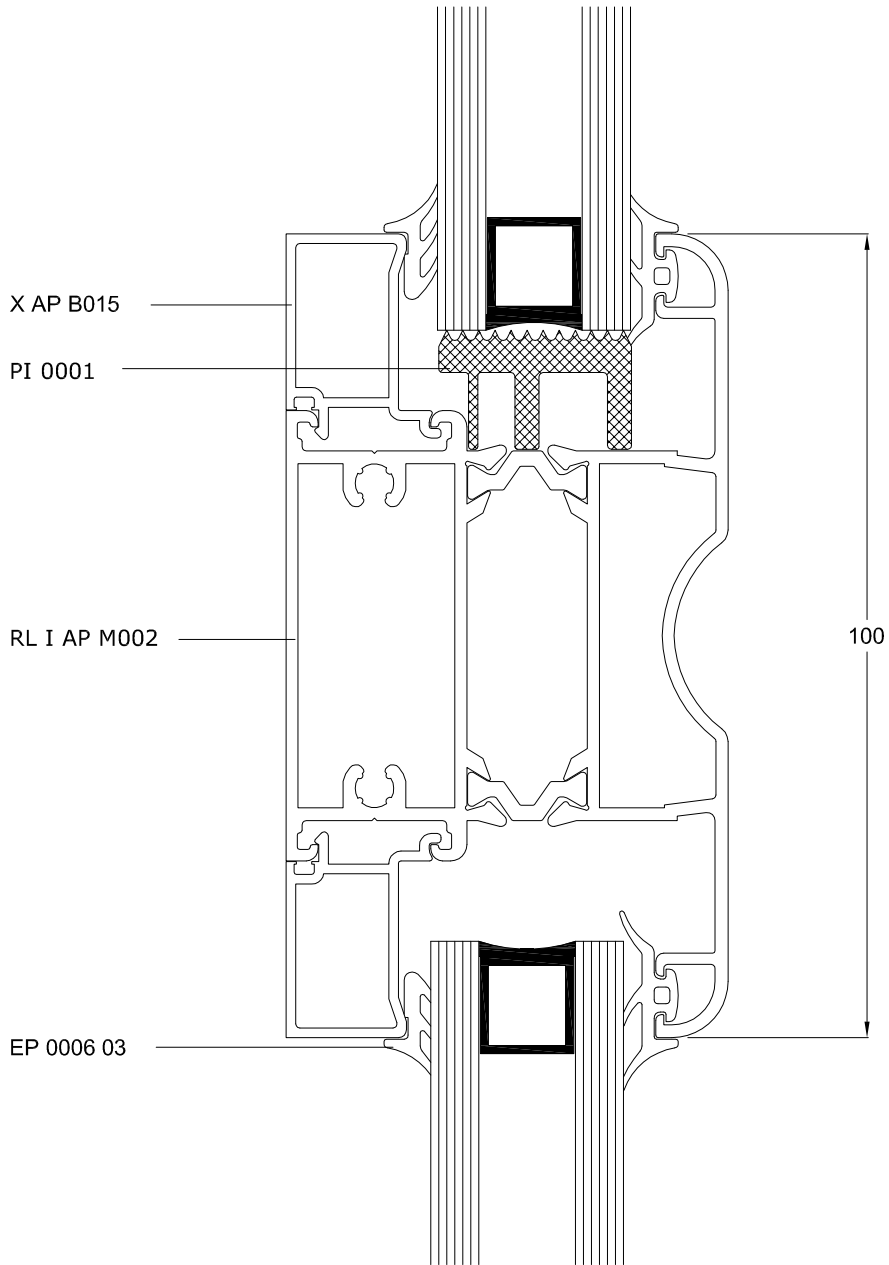

Red Line

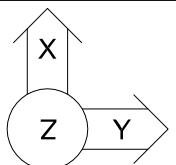
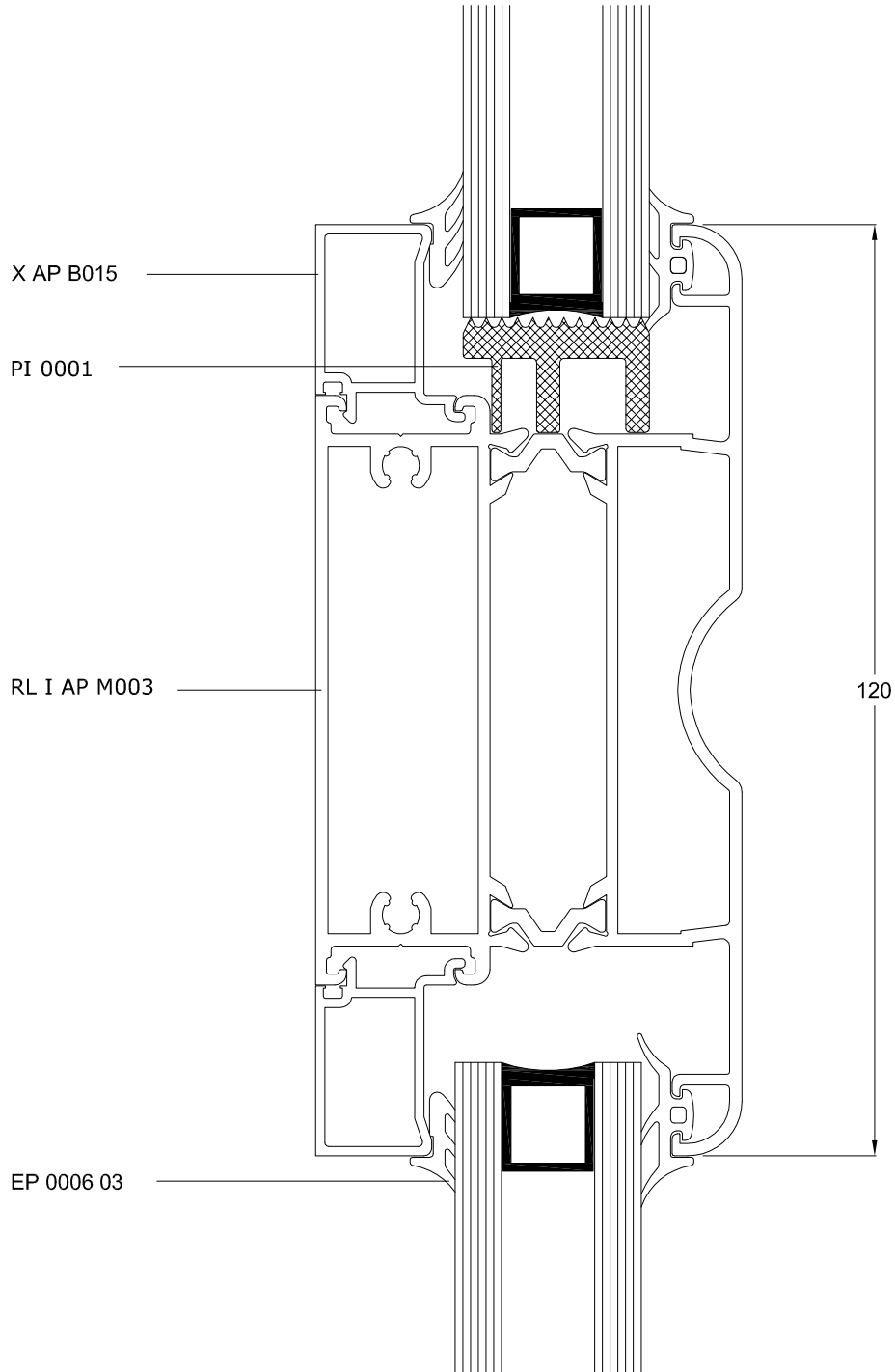

Scale: 1/1

Red Line

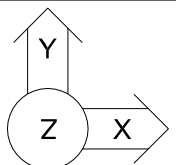
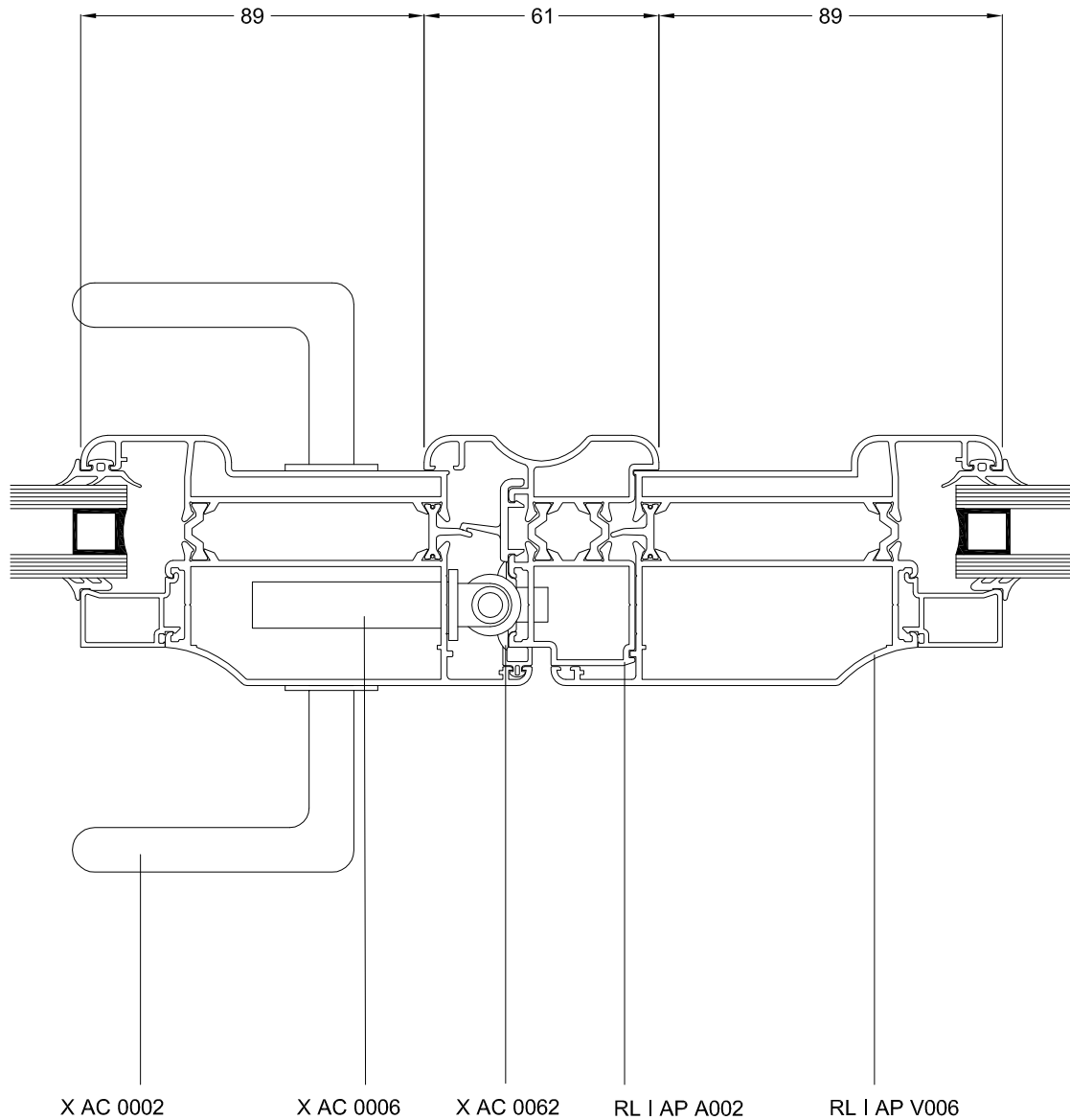

Scale: 1/2

Red Line

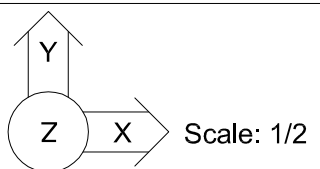
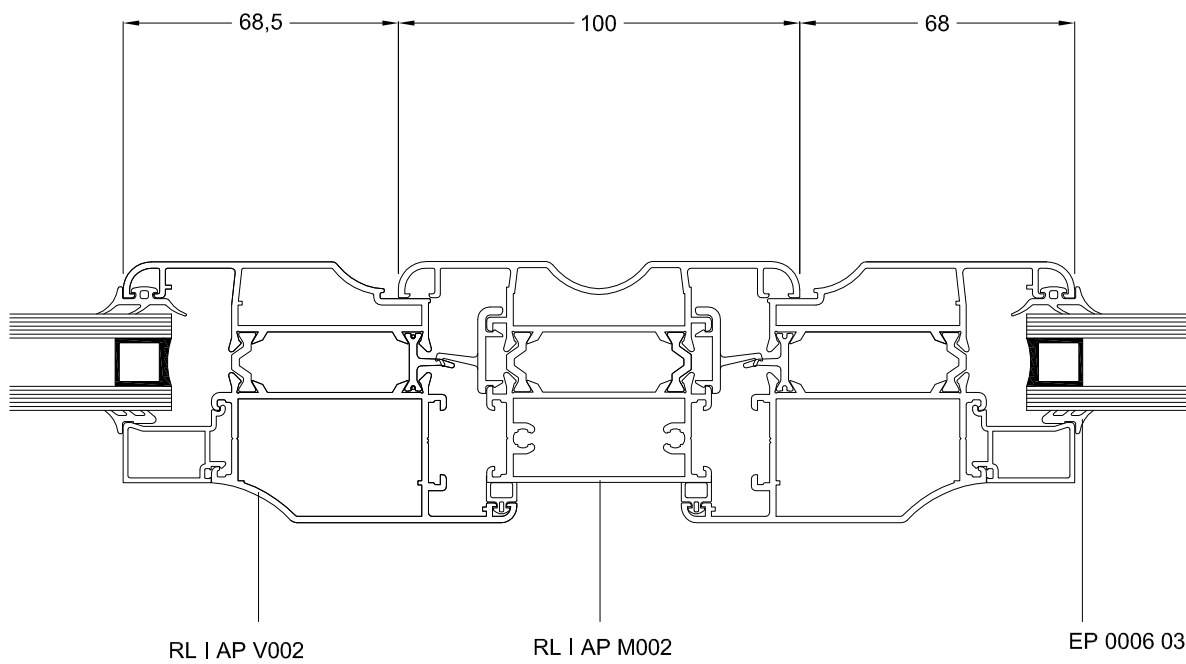

Red Line



X AP B007

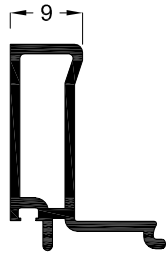

X AP B009

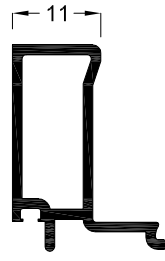

X AP B011



X AP B013

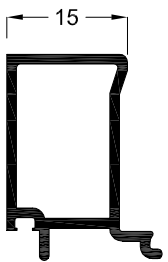

X AP B015

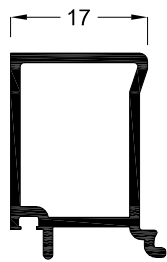

X AP B017

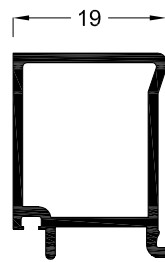

X AP B019

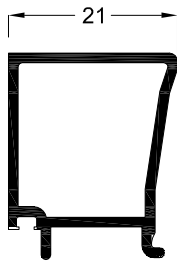

X AP B021

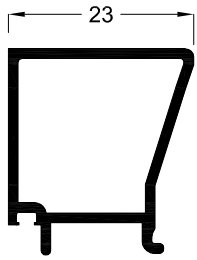

X AP B023

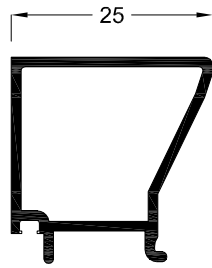

X AP B025

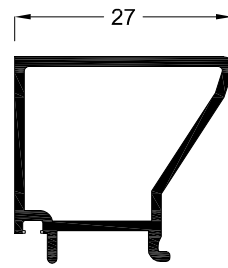

X AP B027

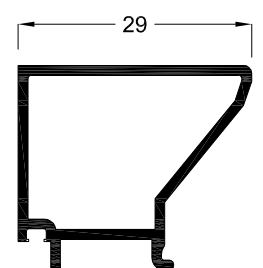

X AP B029

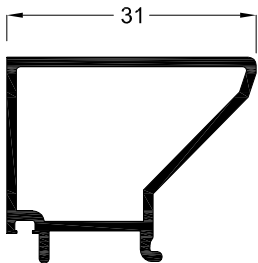

X AP B031

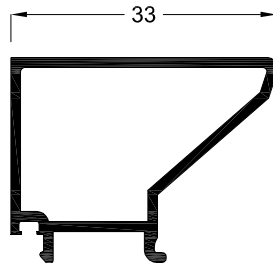



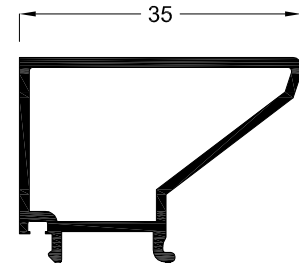

X AP B033





X AP B035

Red Line

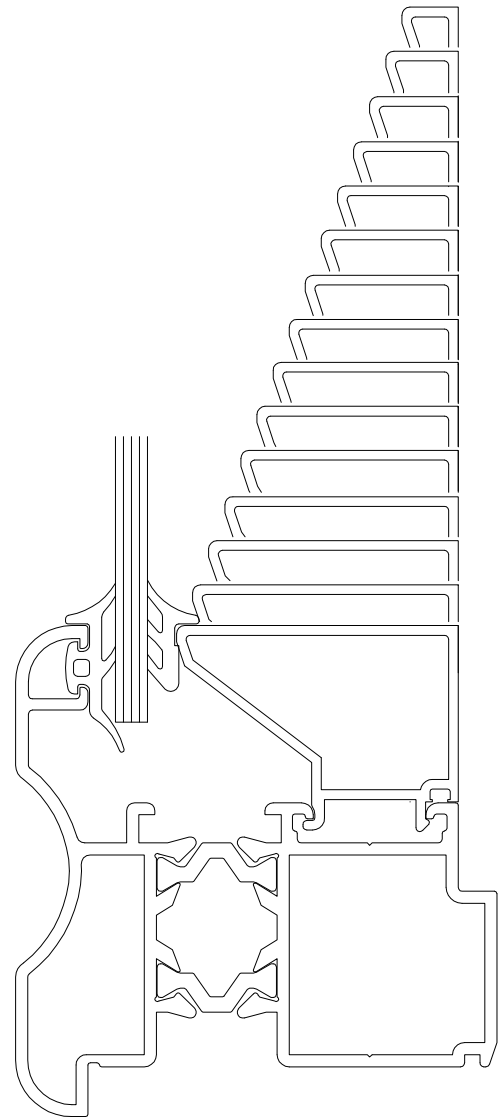
			
EP 0001 03	4 mm	EP 0006 04	X AP B035
EP 0001 03	5 mm	EP 0006 03	X AP B035
EP 0001 03	6 mm	EP 0006 04	X AP B033
EP 0001 03	7 mm	EP 0006 03	X AP B033
EP 0001 03	8 mm	EP 0006 04	X AP B031
EP 0001 03	9 mm	EP 0006 03	X AP B031
EP 0001 03	10 mm	EP 0006 04	X AP B029
EP 0001 03	11 mm	EP 0006 03	X AP B029
EP 0001 03	12 mm	EP 0006 04	X AP B027
EP 0001 03	13 mm	EP 0006 03	X AP B027
EP 0001 03	14 mm	EP 0006 04	X AP B025
EP 0001 03	15 mm	EP 0006 03	X AP B025
EP 0001 03	16 mm	EP 0006 04	X AP B023
EP 0001 03	17 mm	EP 0006 03	X AP B023
EP 0001 03	18 mm	EP 0006 04	X AP B021
EP 0001 03	19 mm	EP 0006 03	X AP B021
EP 0001 03	20 mm	EP 0006 04	X AP B019
EP 0001 03	21 mm	EP 0006 03	X AP B019
EP 0001 03	22 mm	EP 0006 04	X AP B017
EP 0001 03	23 mm	EP 0006 03	X AP B017
EP 0001 03	24 mm	EP 0006 04	X AP B015
EP 0001 03	25 mm	EP 0006 03	X AP B015
EP 0001 03	26 mm	EP 0006 04	X AP B013
EP 0001 03	27 mm	EP 0006 03	X AP B013
EP 0001 03	28 mm	EP 0006 04	X AP B011
EP 0001 03	29 mm	EP 0006 03	X AP B011
EP 0001 03	30 mm	EP 0006 04	X AP B009
EP 0001 03	31 mm	EP 0006 03	X AP B009
EP 0001 03	32 mm	EP 0006 04	X AP B007
EP 0001 03	33 mm	EP 0006 03	X AP B007





Red Line

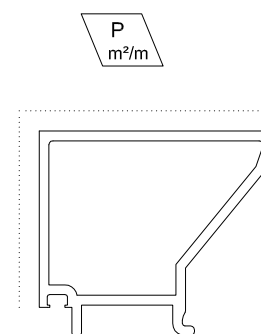
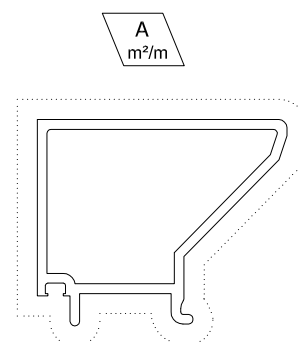



	 A m ² /m	 P m ² /m	Kg / m
X AP B007	0,09	0,03	0,23
X AP B009	0,10	0,03	0,24
X AP B011	0,10	0,04	0,25
X AP B013	0,10	0,04	0,26
X AP B015	0,10	0,04	0,26
X AP B017	0,10	0,04	0,27
X AP B019	0,10	0,04	0,28
X AP B021	0,10	0,05	0,29
X AP B023	0,10	0,05	0,29
X AP B025	0,11	0,05	0,30
X AP B027	0,11	0,05	0,31
X AP B029	0,11	0,06	0,32
X AP B031	0,12	0,06	0,33
X AP B033	0,12	0,05	0,34
X AP B035	0,12	0,06	0,36

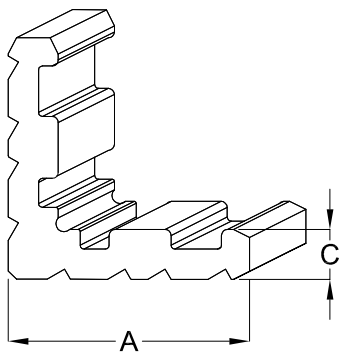
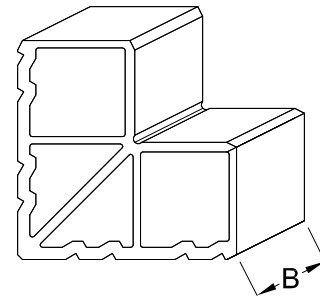

Red Line

	A	B		C
X AP C124	60 mm	18,7 mm	X AP C124/187	12,4 mm
X AP C244	60 mm	18,9 mm	X AP C244/189	24,4mm
X AP C254	60 mm	20 mm	X AP C254/200	25,4 mm
X AP C454	80 mm	20 mm	X AP C454/200	45,4 mm
X AP C654	80 mm	20 mm	X AP C654/200	65,4 mm



			
X AP C124	18,7 mm	RL I AP F001	X AP C124/187
X AP C124	18,9 mm	RL I AP F002	X AP C124/189
X AP C124	18,7 mm	RL I AP F005	X AP C124/187
X AP C244	18,9 mm	RL I AP F006	X AP C244/189
X AP C254	38,3 mm	RL I AP F001	X AP C254/383
X AP C254	20 mm	RL I AP V001	X AP C254/200
X AP C454	20 mm	RL I AP V002	X AP C454/200
X AP C654	20 mm	RL I AP V003	X AP C654/200
X AP C654	18,9 mm	RL I AP V005	X AP C654/189
X AP C654	20 mm	RL I AP V006	X AP C654/200