



Orta Sürme Serisi / Middle Sliding Wall / Mittlere Schiebewand



	A m ² /m	P m ² /m	Jx	Jy						Kg / m
OS N AP V001	0,28	0,14	9,52	6,42	-	-	-	-	-	0,89
OS N AP V002	0,24	0,13	10,8	6,61	X AP C320/	38,6	-	X AP C320	-	0,79
OS N AP V003	0,29	0,13	10,8	6,45	-	-	-	-	-	0,99
OS N AP V004	0,29	0,10	9,33	8,45	X AP C320/	32,6	-	X AP C320	-	0,90
OS N AP P001	0,17	-	-	-	-	-	-	-	-	0,35

	
OS N AP V001	OS N AP V002
	
OS N AP V003	OS N AP V004
	
OS N AP P001	

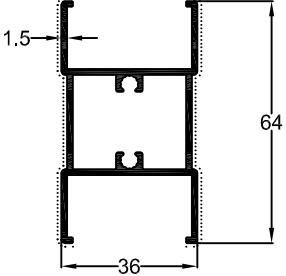
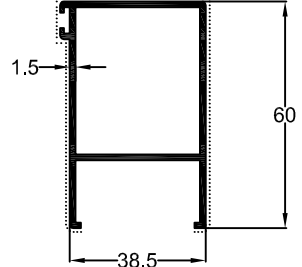
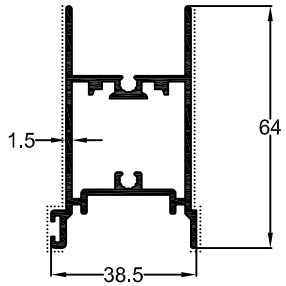
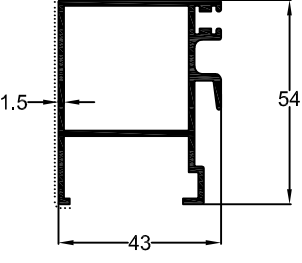
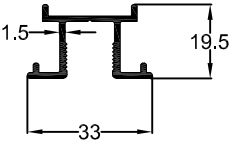
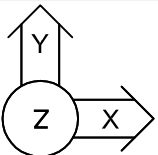

Scale: 1/2

Orta Sürme Serisi / Middle Sliding Wall / Mittlere Schiebewand

	A m ² /m	P m ² /m	Jx	Jy						Kg / m
OS N AP F001	0,42	0,08	2,78	35,9	-	-	-	-	-	0,94
OS N AP F002	0,54	0,12	7,43	47,9	-	-	-	-	-	1,22
OS N AP F003	0,63	0,12	9,08	57,2	-	-	-	-	-	1,62

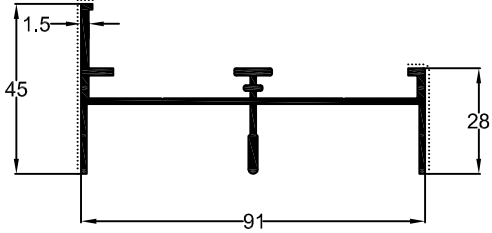
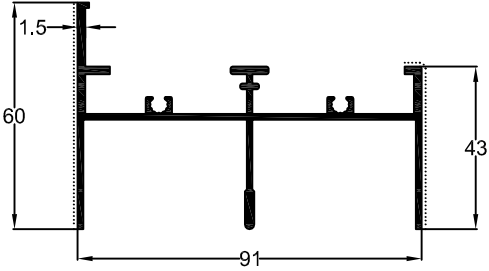
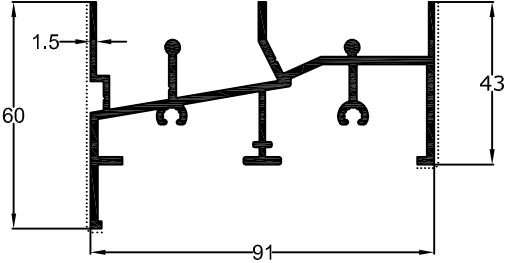
	
OS N AP F001	OS N AP F002
	
OS N AP F003	

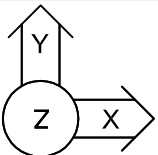



Scale:1/2

Orta Sürme Serisi / Middle Sliding Wall / Mittlere Schiebewand

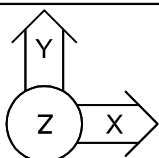
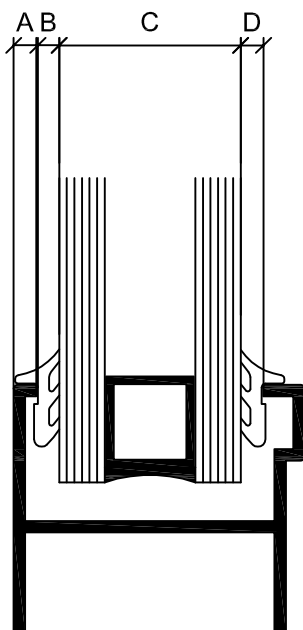
A	B	C	D
-	EP 0007 04	22 mm	EP 0007 04
-	EP 0006 03	24 mm	EP 0006 03
-	EP 0007 04	22 mm	EP 0007 04
-	EP 0006 03	24 mm	EP 0006 03



Orta Sürme Serisi / Middle Sliding Wall / Mittlere Schiebewand

	Kg / m	A	B		C
X AP C320	4.746	81	38,6	X AP C320/386	32
X AP C320	4.746	81	32,6	X AP C320/326	32

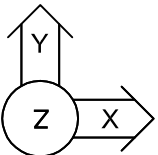
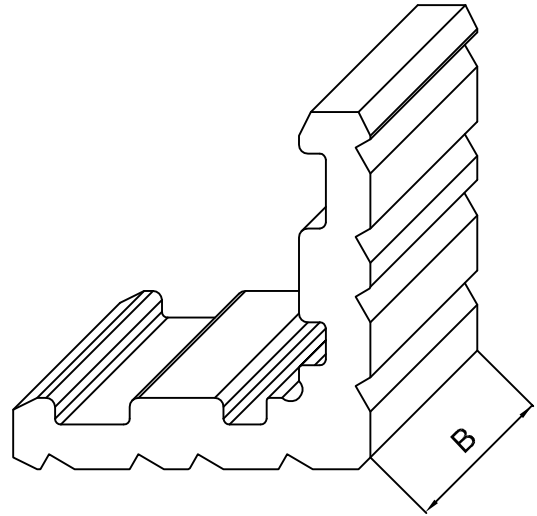
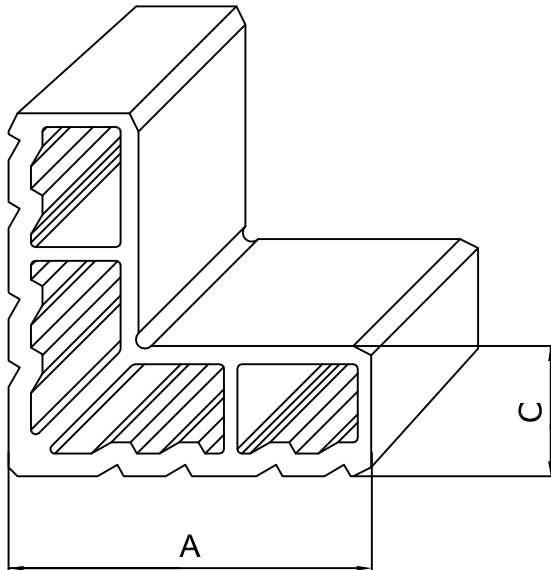

Orta Sürme Serisi / Middle Sliding Wall / Mittlere Schiebewand

	Tanımlama	Description	Beschreibung
OS N AP V002	Kanat	Vent	Flügel
OS N AP F001	Kasa	Frame	Rahmen
EP 0006 03	İç Cam Fitili	Inner Glass Gasket	Innere Glasdichtung
EP 0006 03	Dış Cam Fitili	Outer Glass Gasket	Äussere Glasdichtung
BR 0001 05	Fırça	Brush	Bürste

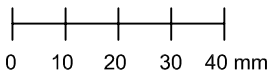
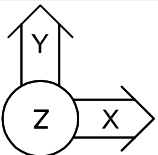
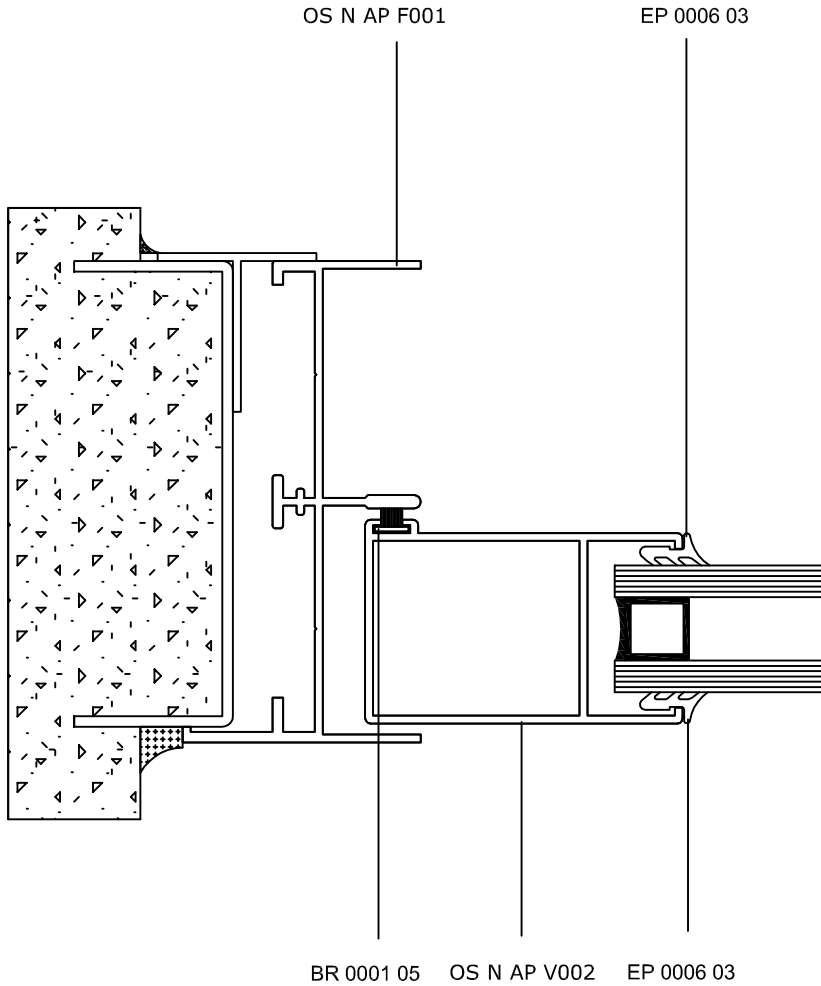
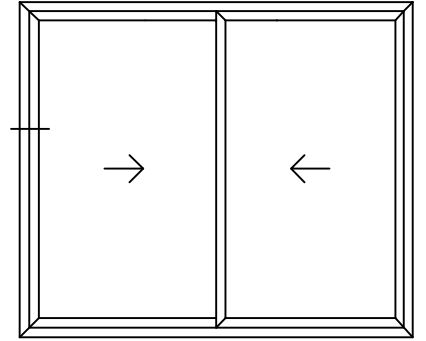

Orta Sürme Serisi / Middle Sliding Wall / Mittlere Schiebewand

	Tanımlama	Description	Beschreibung
OS N AP V004	Kanat	Vent	Flügel
EP 0006 03	İç Cam Fiteli	Inner Glass Gasket	Innere Glasdichtung
EP 0006 03	Dış Cam Fiteli	Outer Glass Gasket	Äussere Glasdichtung
BR 0001 05	Fırça	Brush	Bürste

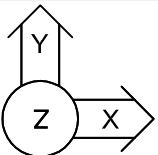
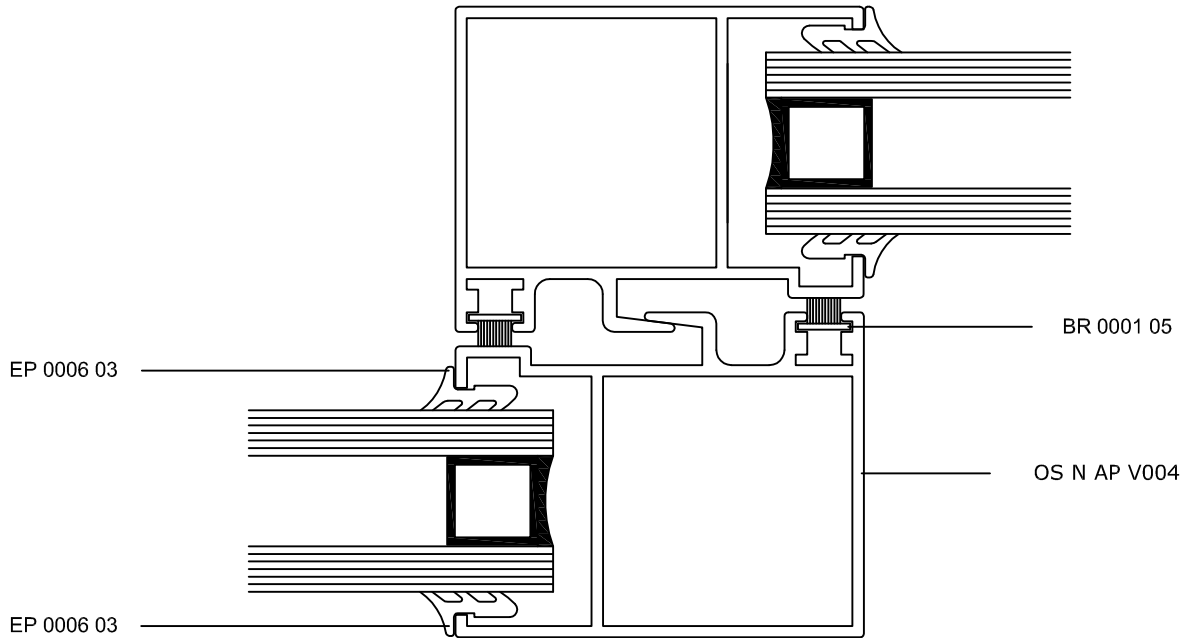
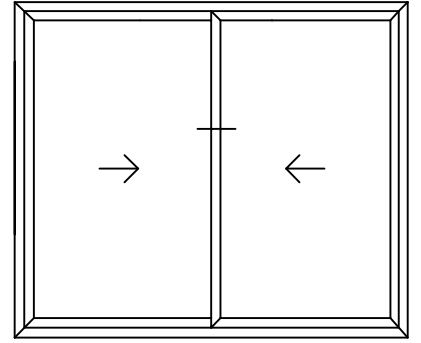

Scale: 1/1

Orta Sürme Serisi / Middle Sliding Wall / Mittlere Schiebewand

	Tanımlama	Description	Beschreibung
OS N AP F002	Kasa	Frame	Rahmen
OS N AP V003	Kanat	Vent	Flügel
EP 0006 03	İç Cam Fıtlı	Inner Glass Gasket	Innere Glasdichtung
EP 0006 03	Dış Cam Fıtlı	Outer Glass Gasket	Äussere Glasdichtung
BR 0001 05	Fırça	Brush	Bürste

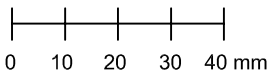
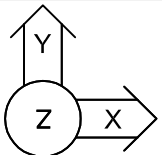
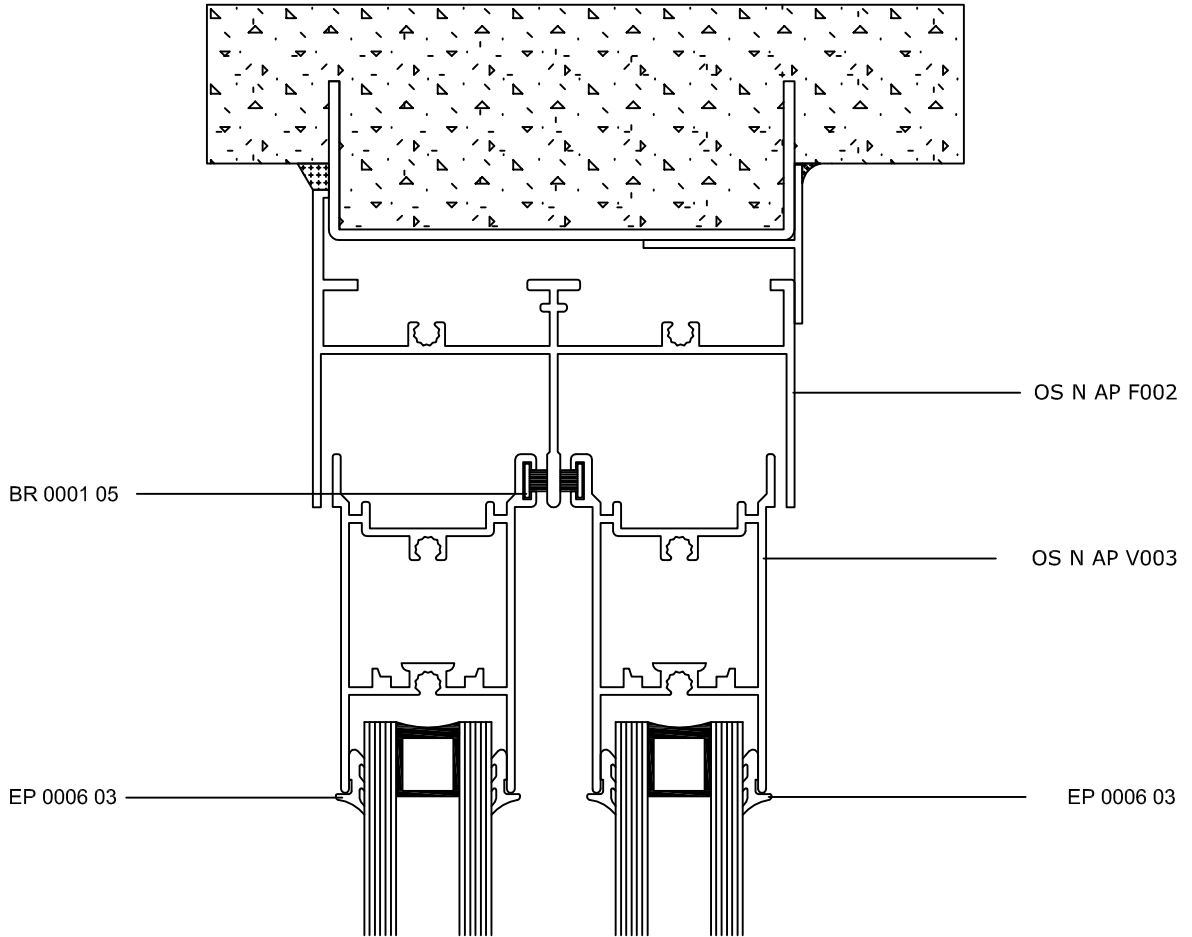
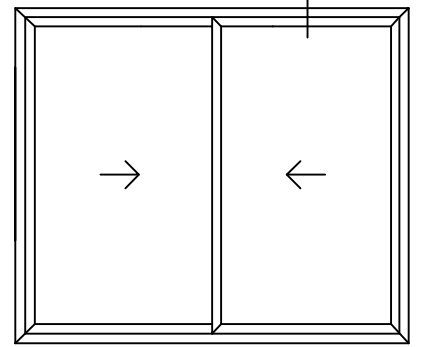

Orta Sürme Serisi / Middle Sliding Wall / Mittlere Schiebewand

	Tanımlama	Description	Beschreibung
OS N AP F003	Kasa	Frame	Rahmen
OS N AP V003	Kanat	Vent	Flügel
EP 0006 03	İç Cam Fıtlı	Inner Glass Gasket	Innere Glasdichtung
EP 0006 03	Diş Cam Fıtlı	Outer Glass Gasket	Äussere Glasdichtung
BR 0001 05	Fırça	Brush	Bürste
X AC-0066	Rulman	Roller	Rollenwagen
PI 0002	Cam Takozu	Glass Block	Verglasungsklotz
PP 0001	Rulman Yalıtımı	Roller Carriage Bowl	Rollenwagenisolerung

